



WOOD

Wood spiral stairs are made of red oak and come in a variety of styles (contemporary shown above). Options include turned balusters and profiled handrail, for a traditional design, and square balusters and handrail for a modern look.



METAL

All-metal spiral stairs are offered in steel, for interior use, and aluminum, for exterior applications.

All spiral stairs are shipped knocked down and require job-site assembly.

Lead times vary from 4-8 weeks, depending upon style and options selected.

We recommend consulting your local permit office for codes regarding spiral stairs.

Post to Post & Post to Post with Fittings

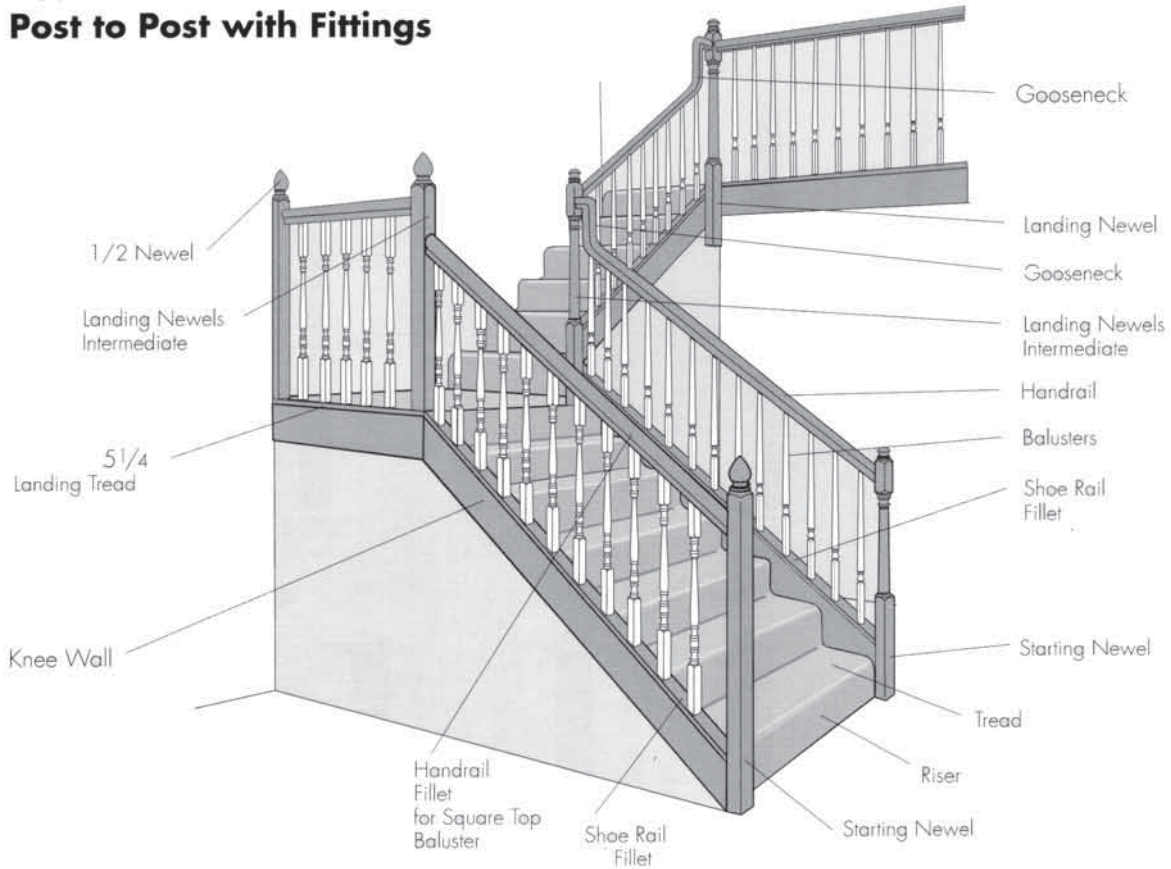

Over the Post

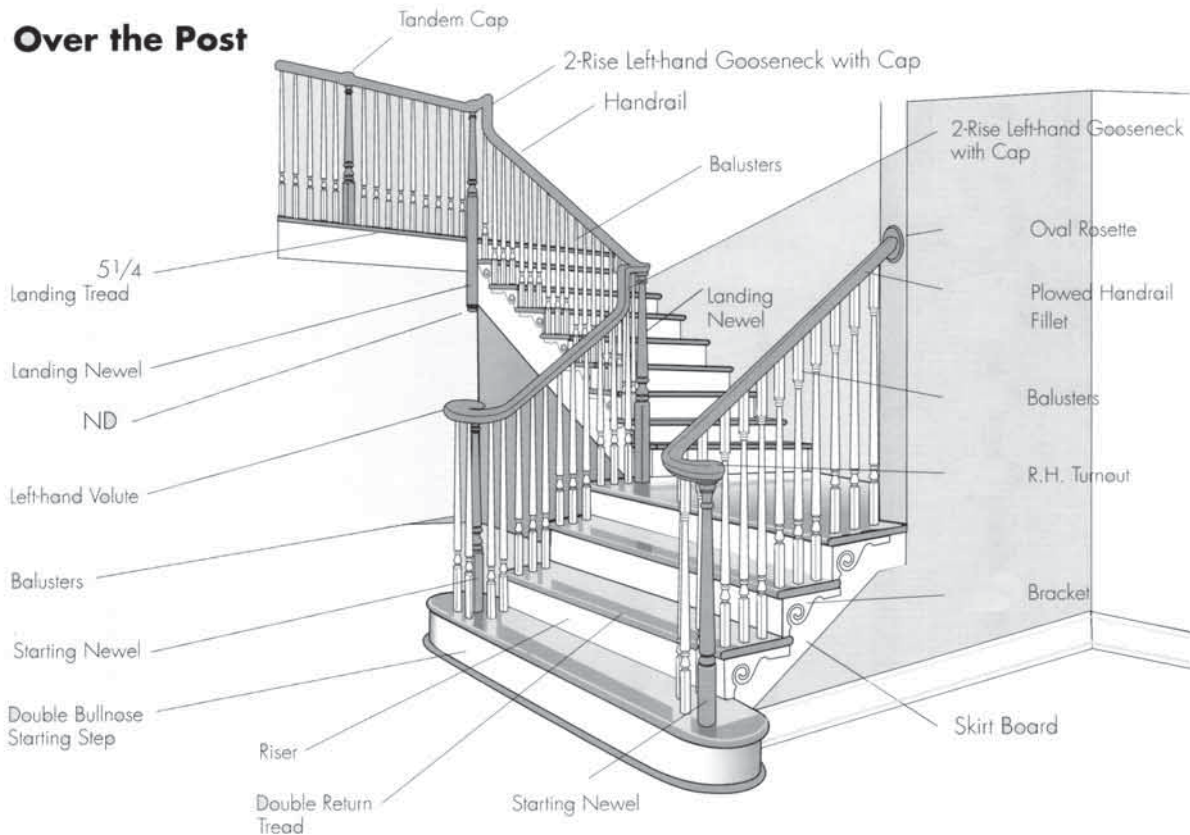

★ Variation in product are used for example only.



CUSTOM PLOWING
AVAILABLE

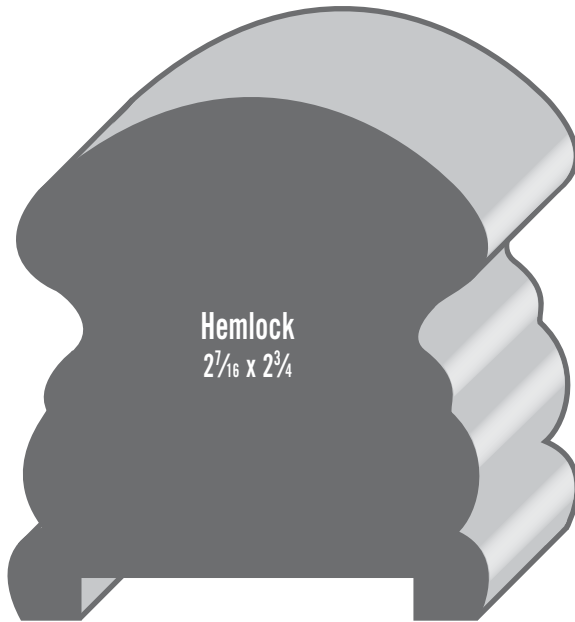

Hemlock
2⁷/₁₆ x 2³/₄

HEMLOCK • FingerJoint H 6019P2 1⁵/₈ Plow (fillet included)



Alder
Cherry
2⁵/₈ x 2³/₈

ALDER • A 6510 No Plow CHERRY • C 6510 No Plow
A 6510BR Bending Rail
P 6515 Bending Mould

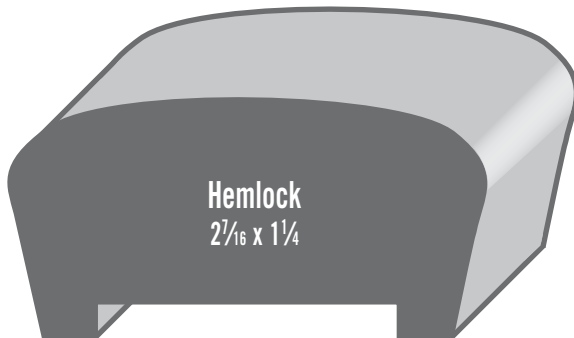

Hemlock
2⁷/₁₆ x 1¹/₄

HEMLOCK • H 6244P2 1⁵/₈ Plow (fillet included)

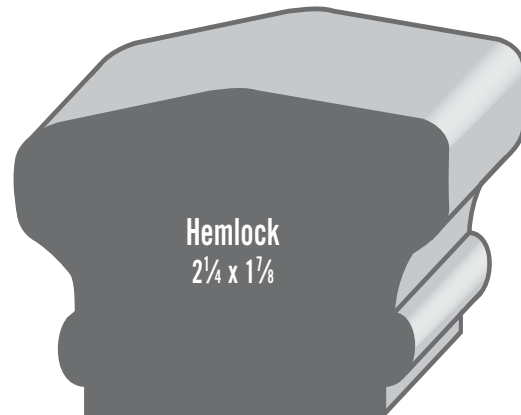

Hemlock
2¹/₄ x 1¹/₈

HEMLOCK • H 6910 No Plow

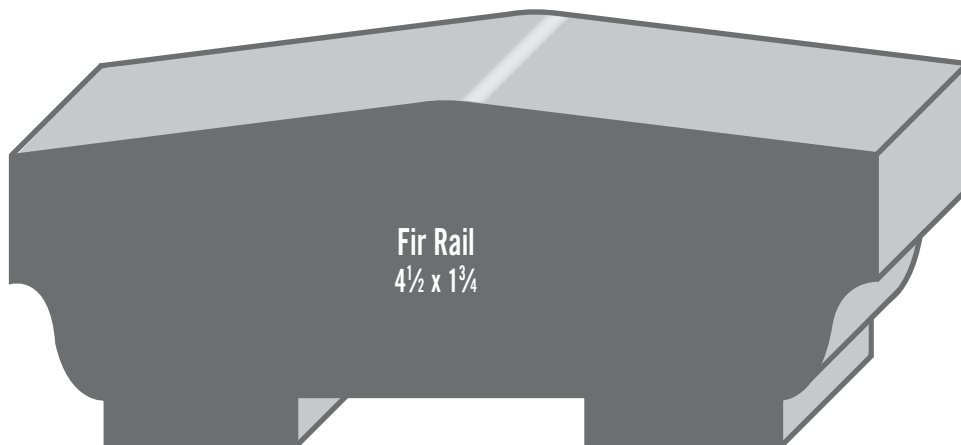

Fir Rail
4¹/₂ x 1³/₄

Fir Rail 1¹/₂" Plow



CUSTOM PLOWING AVAILABLE

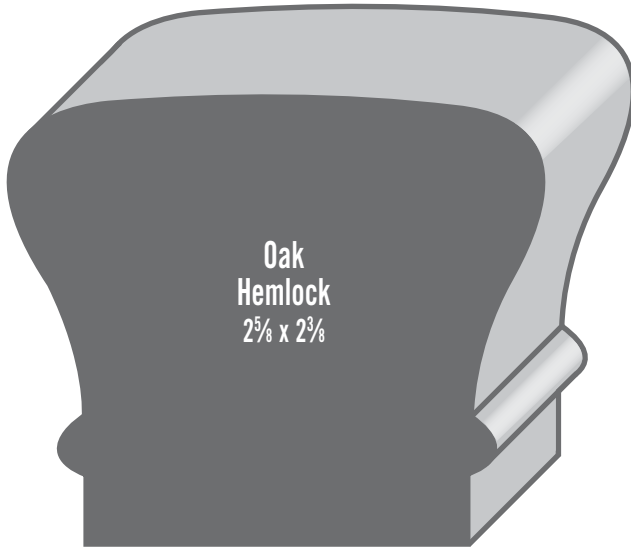

Oak
Hemlock
2 5/8 x 2 3/8

OAK • O 6210 No Plow
O 6210BR Bending Rail
P 6015 Bending Mould

HEMLOCK • H 6210 No Plow
H 6210P2 1 5/8 Plow
(fillet included)

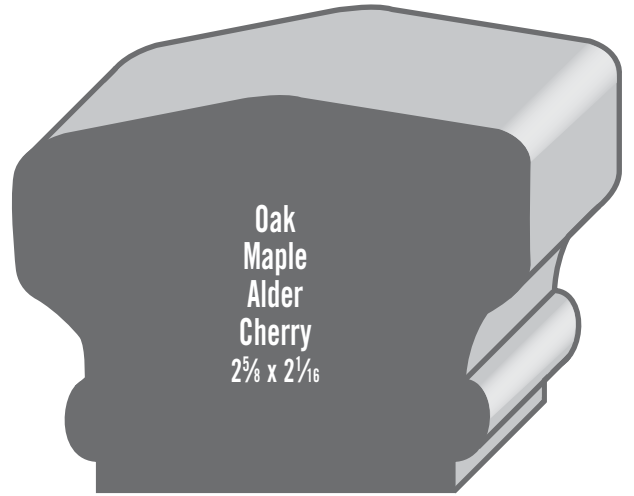

Oak
Maple
Alder
Cherry
2 5/8 x 2 1/16

OAK • O 6910 No Plow
O 6910P 1 1/4 Plow
O 6910BR Bending Rail
O 6910 Spec 16' 1 Finger Joint
O 6910 Spec 18' 1 Finger Joint

ALDER • A 6910 No Plow
A 6910P 1 1/4 Plow
A 6910BR Bending Rail
All Alder Rail is Finger Jointed

MAPLE • M 6910 No Plow
M 6910P 1 1/4 Plow
M 6910BR Bending Rail
M 6910 Spec 16' 1 Finger Joint
M 6910 Spec 18' 1 Finger Joint

CHERRY • C 6910 No Plow
C 6910BR Bending Rail
C 6910 Spec 16' 1 Finger Joint
P 6915 Bending Mould



Oak
Maple
Cherry
Hemlock
2 1/4 x 2 3/8

OAK • O 6010 No Plow
O 6010P 1 1/4 Plow
O 6010BR Bending Rail
P 6015 Bending Mould

CHERRY • C 6010 No Plow

HEMLOCK • H 6010 No Plow
H 6010P 1 1/4 Plow
(fillet included)
H 6010BR Bending Rail
(bending mould included)

MAPLE • M 6010 No Plow

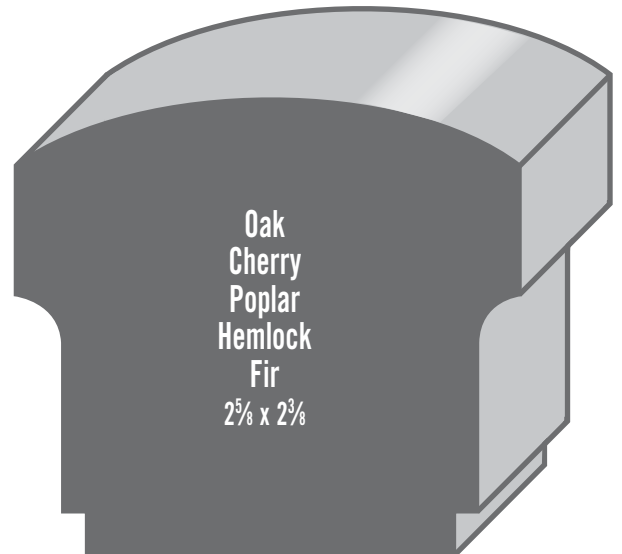

Oak
Cherry
Poplar
Hemlock
Fir
2 5/8 x 2 3/8

OAK • O 6500 No Plow
CHERRY • C 6500 No Plow
POPLAR • P 6500 No Plow

HEMLOCK • H 6500 No Plow
FIR • F 6500 No Plow

CUSTOM HANDRAILS AVAILABLE BY SPECIAL ORDER



3/8
1 3/4
OAK • O 6007 P1
MAPLE • M 6007 P1
CHERRY • C 6007 P1



3/8
1 5/8
OAK • O 6007 P2
MAPLE • M 6007 P2
CHERRY • C 6007 P2
ALDER • A 6007 P2

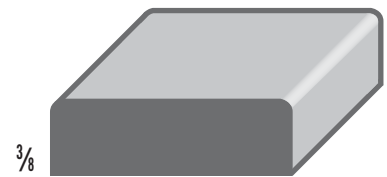

3/8
1 1/4
OAK • O 6050
MAPLE • M 6050
CHERRY • C 6050
ALDER • A 6050

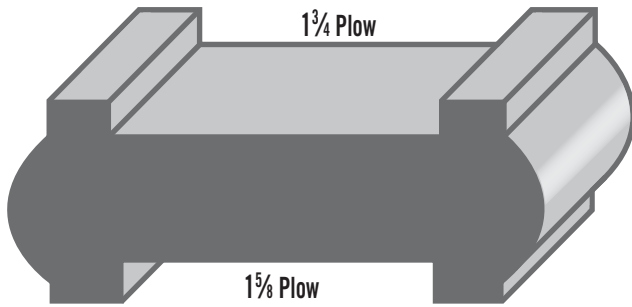

OAK • O 6006
MAPLE • M 6006
CHERRY • C 6006

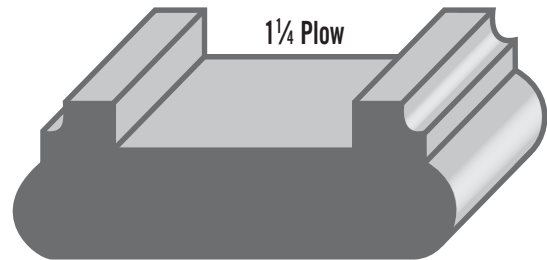

OAK • O 6045
MAPLE • M 6045
CHERRY • C 6045
ALDER • A 6045



1/4"
1 5/8 Fillet H 6007P2
1 1/4 Fillet H 6050

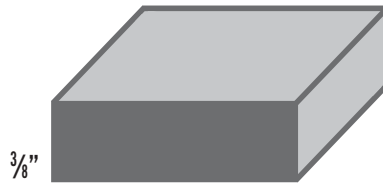

3/8"
1/4 F 6050



3/8"
1/2 F 6051

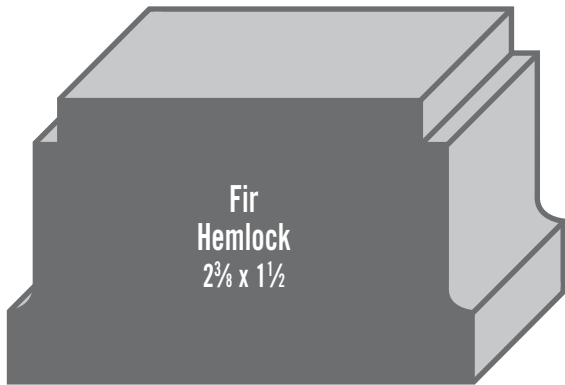

F 6545 No Plow
H 6545 No Plow

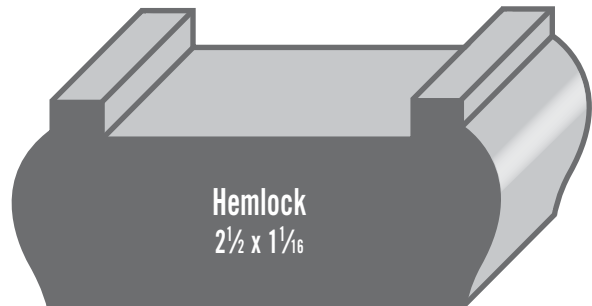

H 6006 1 5/8 Plow (fillet included)
H 6045 1 1/4 Plow (fillet included)

CUSTOM PLOWING AVAILABLE



Fir Shoe
3 1/2 x 1 1/2

Fir Shoe



UTILITY RAIL

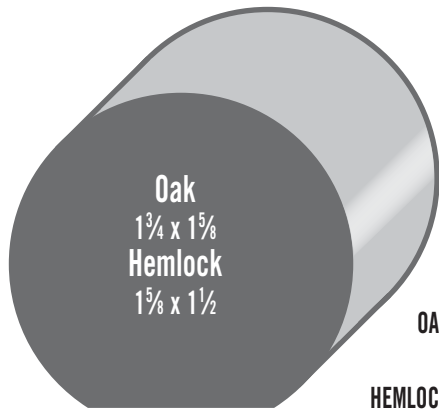

Oak
1 3/4 x 1 5/8
Hemlock
1 5/8 x 1 1/2

OAK • O 6040
O 7023 Quarterturn
HEMLOCK • H 6040

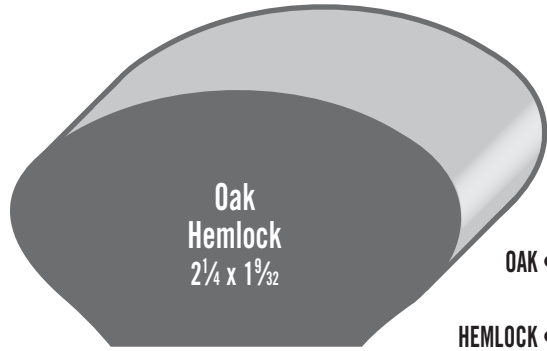

Oak
Hemlock
2 1/4 x 1 9/32

OAK • O 6042
O 7005 Quarterturn
HEMLOCK • H 6042



HANDRAIL BRACKETS



*Off set; center of rail screws to wall; screws included

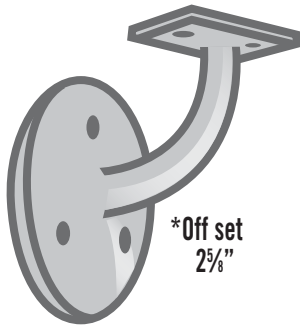

*Off set
2 5/8"

S 3027 Solid Brass
S 3060 US26D Brushed Chrome

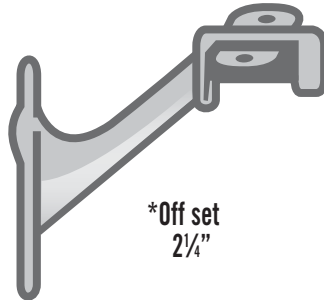

*Off set
2 1/4"

S 3002 Bright Brass
S 3002A Antique Brass

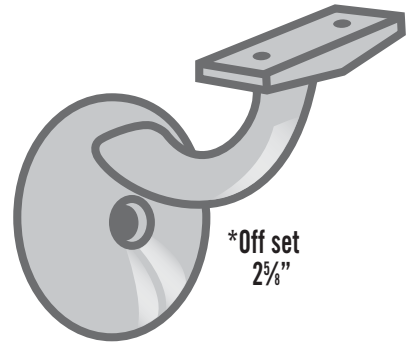

*Off set
2 5/8"

S 3008B Black
S 3007BN Brushed Nickel
S 3005 ORB Oil Rubbed Bronze



STAIR HARDWARE & BRACKETS

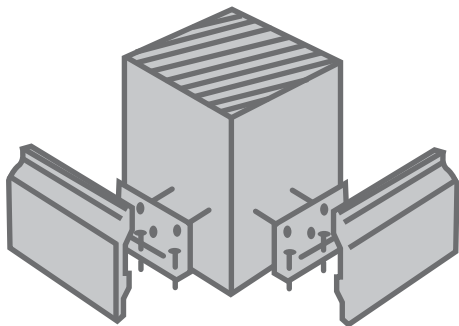

L-Bracket Newel Fastener
O 3007 3" OAK
O 3008 3 1/2" OAK
H 3008 3 1/4" HEMLOCK
S3009 Newel Fastener (no moulding)

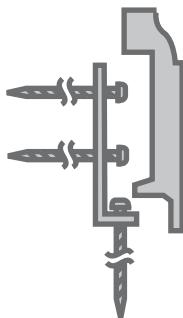

Additional L-Bracket Mouldings
LBM OAK
LBM HEMLOCK
LBM MAPLE
LBM ALDER



S 3005 Sure-Tite Newel Fastener 1/2 x 11
(Includes two 1 1/2" Plugs - Oak & Hemlock)



T 92 Rail Bolt Wrench

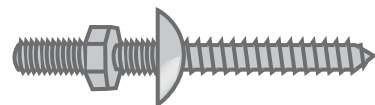

S 3001 Rail Bolt



S 3032 Circ-Runner Rail Bolt Driver



S 3033 Dowel Runner
Dowel Screw Driver



S 3076 Dowel Screw
Lag Screw for Balusters
5/16 x 2 1/16



Lead time on non-stock fittings is typically 3-5 days

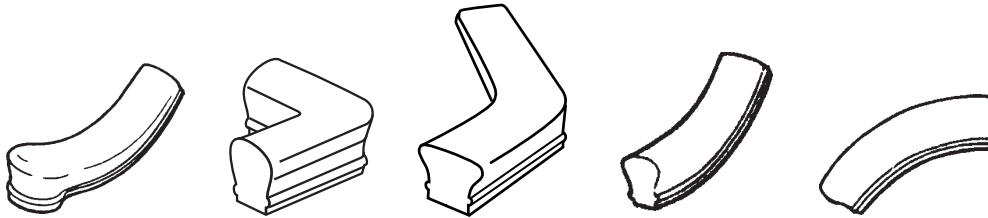

RAIL	STARTING EASING	LEVEL QUARTERTURN	LEVEL EIGHTH TURN	UP EASING	OVER EASING
H6010 HEM	H7010	H7011	N/A	H7012	H7013
O6010 OAK	O7010	O7011	O7011-135	O7012	O7013
C6010 CHERRY	C7010	C7011	C7011-135	C7012	C7013
M6010 MAPLE	M7010	M7011	M7011-135	M7012	M7013
O6210 OAK	O7210	O7211	O7211-135	O7212	O7213
C6910 CHERRY	C7910	C7911	C7911-135	C7912	C7913
O6910 OAK	O7910	O7911	O7911-135	O7912	O7913
M6910 MAPLE	M7910	M7911	M7911-135	M7912	M7913
A6910 ALDER	A7910	A7911	A7911-135	A7912	A7913
H6910 HEM	H7910	H7911	N/A	H7912	H7913

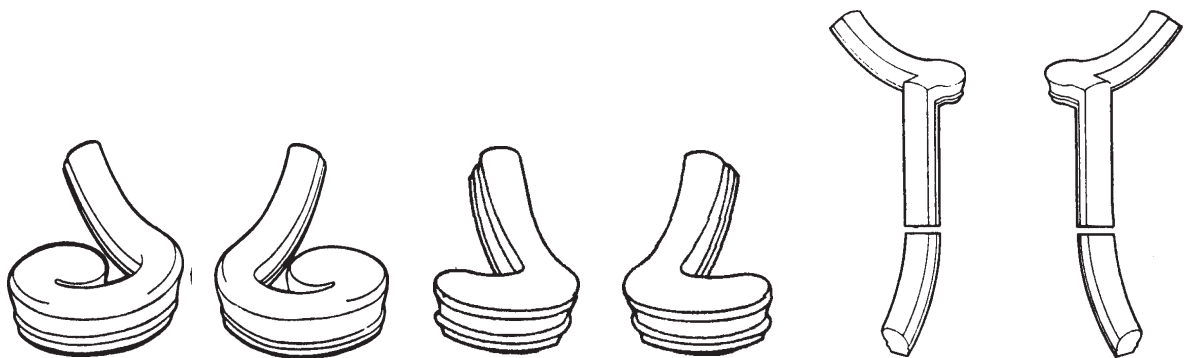

RAIL	VOLUTE LEFT HAND	VOLUTE RIGHT HAND	TURNOUT LEFT HAND	TURNOUT RIGHT HAND	GOOSENECK LEFT HAND 2 RISER W/ CAP & UPEASING	GOOSENECK RIGHT HAND 2 RISER W/ CAP & UPEASING
H6010 HEM	H7030	H7035	H7040	H7045	H7060	H7065
O6010 OAK	O7030	O7035	O7040	O7045	O7060	O7065
C6010 CHERRY	C7030	C7035	C7040	C7045	C7060	C7065
M6010 MAPLE	M7030	M7035	M7040	M7045	M7060	M7065
O6210 OAK	O7230	O7235	O7240	O7245	O7260	O7265
C6910 CHERRY	C7930	C7935	C7940	C7945	N/A	N/A
O6910 OAK	O7930	O7935	O7940	O7945	N/A	N/A
M6910 MAPLE	M7930	M7935	M7940	M7945	N/A	N/A
A6910 ALDER	A7930	A7935	A7940	A7945	N/A	N/A
H6910 HEM	H7930	H7935	H7940	H7945	N/A	N/A



Lead time on non-stock fittings is typically 3-5 days

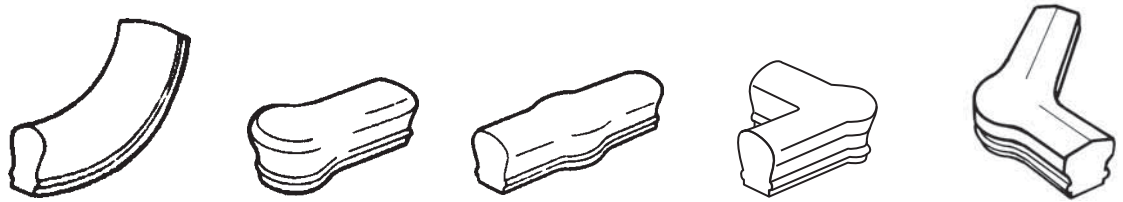

RAIL	UPEASING 90 DEGREE	OPENING CAP	TANDEM CAP	LEVEL 1/4 TURN WITH CAP	LEVEL 1/8 TURN WITH CAP
H6010 HEM	H7014	H7019	H7020	H7021	H7021-135
O6010 OAK	O7014	O7019	O7020	O7021	O7021-135
C6010 CHERRY	C7014	C7019	C7020	C7021	C7021-135
M6010 MAPLE	M7014	M7019	M7020	M7021	M7021-135
O6210 OAK	O7214	O7219	O7220	O7221	O7221-135
C6910 CHERRY	C7914	C7919	C7920	C7921	C7921-135
O6910 OAK	O7914	O7919	O7920	O7921	O7921-135
M6910 MAPLE	M7914	M7919	M7920	M7921	M7921-135
A6910 ALDER	A7914	A7919	A7920	A7921	A7921-135
H6910 HEM	H7914	H7919	H7920	H7921	N/A

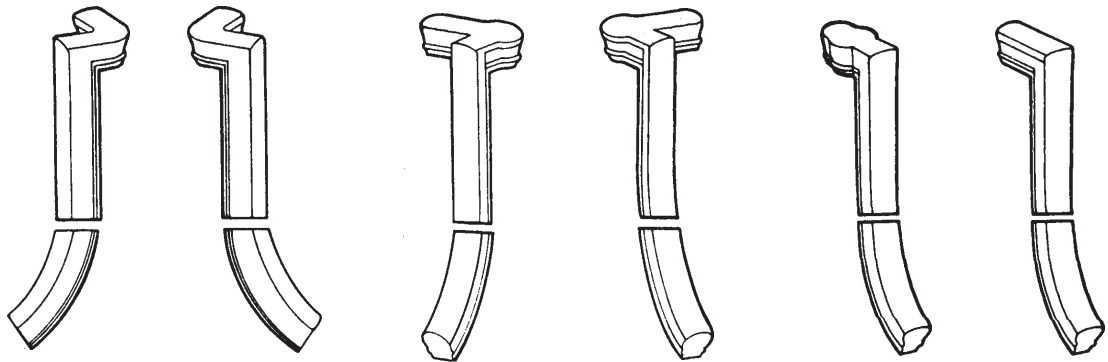

RAIL	GOOSENECK LEFT HAND 2 RISER NO CAP	GOOSENECK RIGHT HAND 2 RISER NO CAP	GOOSENECK LEFT HAND 2 RISER W/ CAP	GOOSENECK RIGHT HAND 2 RISER W/ CAP	GOOSENECK 2 RISER TANDEM CAP	GOOSENECK 2 RISER NO CAP
H6010 HEM	H7071	H7076	H7081	H7086	H7089	H7099
O6010 OAK	O7071	O7076	O7081	O7086	O7089	O7099
C6010 CHERRY	C7071	C7076	C7081	C7086	C7089	C7099
M6010 MAPLE	M7071	M7076	M7081	M7086	M7089	M7099
O6210 OAK	O7271	O7276	O7281	O7286	O7289	O7299
C6910 CHERRY	C7971	C7976	C7981	C7986	C7989	C7999
O6910 OAK	O7971	O7976	O7981	O7986	O7989	O7999
M6910 MAPLE	M7971	M7976	M7981	M7986	M7989	M7999
A6910 ALDER	A7971	A7976	A7981	A7986	A7989	A7999
H6910 HEM	H7971	H7976	H7981	H7986	H7989	H7999

10 NEWELS & BALUSTERS - CANTERBURY

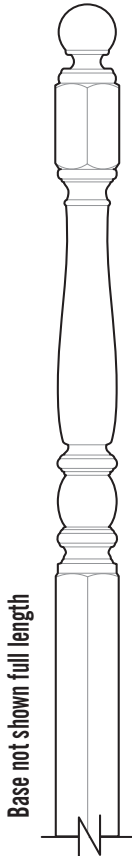

- OAK**
- O 4940
3½ x 52
- O 4942
3½ x 60
- MAPLE**
- M 4940
3½ x 52
- M 4942
3½ x 60
- CHERRY**
- C 4942
3½ x 60
- ALDER**
- A 4942
3½ x 60



- OAK**
 - O 4910
3½ x 48
 - O 4915
3½ x 60
 - MAPLE**
 - M 4910
3½ x 48
 - M 4915
3½ x 60
 - CHERRY**
 - C 4910
3½ x 48
 - C 4915
3½ x 60
 - ALDER**
 - A 4910
3½ x 48
 - A 4915
3½ x 60
- (Including Pin)

FLUTED NEWELS AND BALUSTERS ARE AVAILABLE BY SPECIAL ORDER



- OAK**
- O 5109
1¼ x 36, 42
- POPLAR**
- P 5109
1¼ x 36, 42



- PRIMED**
- PR 5241
1¼ x 36, 42
- PR 5341
1¼ x 36, 42



CHARLESTON

COLONIAL



FLUTED NEWELS AND BALUSTERS ARE AVAILABLE BY SPECIAL ORDER

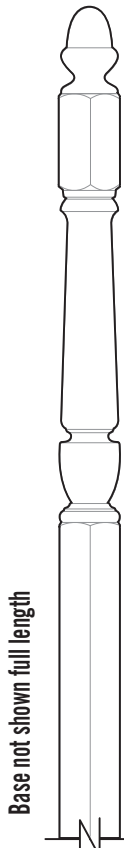

- OAK**
- O 3042
3½ x 56
- CHERRY**
- C 3042
3½ x 56



- CHERRY**
- C 3015
3½ x 56



- PRIMED**
- PR 2015
1⅝ x 36, 42

(Including Pin)

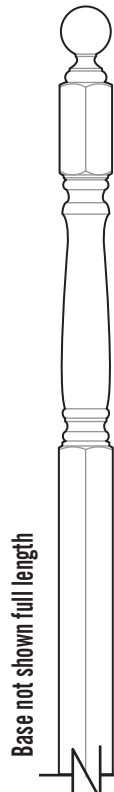

- HEMLOCK**
- H 4842
3¼ x 60



- HEMLOCK**
- H 5801
1¼ x 36, 42



- HEMLOCK**
- H 5802
1⅝ x 32, 36, 42



NOTE SIZE VARIATION IN OAK AND HEMLOCK

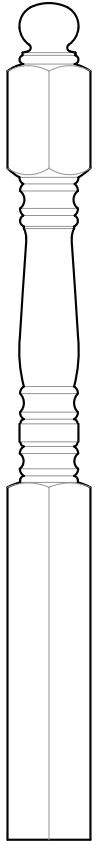

OAK
 O 4500
 3½ x 48
 O 4501
 3½ x 56

HEMLOCK
 H 4500
 3¼ x 48
 H 4501
 3¼ x 60

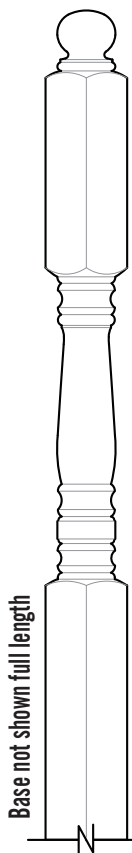

Base not shown full length

OAK
 O 4505
 3½ x 56

HEMLOCK
 H 4505
 3¼ x 60

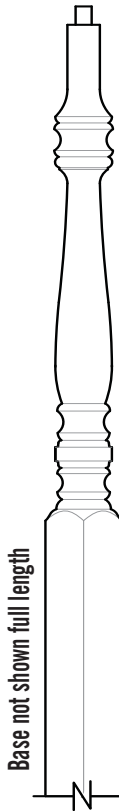

Base not shown full length

OAK
 O 4215
 3½ x 60
 (Including Pin)

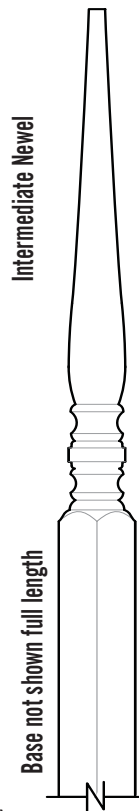

Intermediate Newel

Base not shown full length

HEMLOCK
 H 4216
 3¼ x 48



OAK
 O 5105
 1¼ x 36, 42

HEMLOCK
 H5105
 1¼ x 36, 42
 H 5005
 1½ x 32, 36, 42

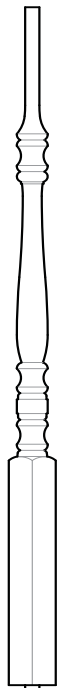

HEMLOCK
 H 5611
 1½ x 36, 42



TRADITIONAL

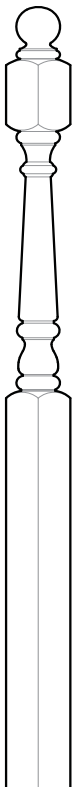

OAK
 O 4140
 3 x 47½

CHERRY
 C 4142
 3 x 53½

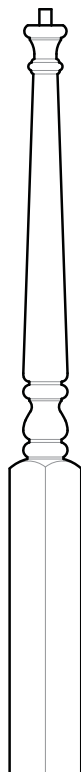

OAK
 O 4010
 3 x 48 (Including Pin)

SPLIT NEWELS ARE AVAILABLE BY SPECIAL ORDER



HEMLOCK
 H 5070
 1¼ x 36, 42

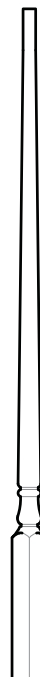

PRIMED
 PR 5015
 1¼ x 36, 42



Box Newels now come with interchangeable flat and pyramid caps.



HEMLOCK
H 3091
5 1/4 x 55

PAINT-GRADE
PG 3091
5 1/4 x 55

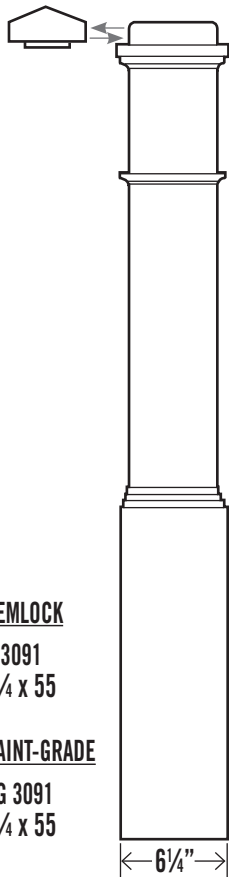

4091 Box Newels now have a hollow base for mounting with the EZ Mount Base Block System.

ALDER
A 4091
4 3/4 x 55

OAK
O 4091
4 3/4 x 55

CHERRY
C 4091
4 3/4 x 55

PAINT-GRADE
PG 4091
4 3/4 x 55



EZ M-01 includes 4 lag screws.

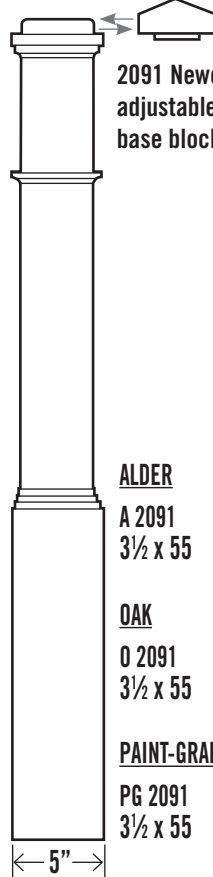

2091 Newel with adjustable length base block

ALDER
A 2091
3 1/2 x 55

OAK
O 2091
3 1/2 x 55

PAINT-GRADE
PG 2091
3 1/2 x 55



OAK
O 4000
3 1/2 x 48
O 4001
3 1/2 x 56

MAPLE
M 4001
3 1/2 x 56

ALDER
A 4001
3 1/2 x 56

CHERRY
C 4000
3 1/2 x 48
C 4001
3 1/2 x 56

HEMLOCK
H 4000
3 1/4 x 47 3/4
H 4001
3 1/4 x 59 3/4



HEMLOCK
H 5001
5 1/4 x 56

Plain Square

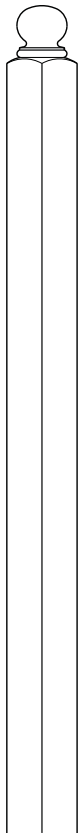

HEMLOCK
H 4105
3 1/4 x 59 3/4



OAK
O 5060
1 1/4 x 36, 42
O 5360
1 3/4 x 36, 42

HEMLOCK
H 5060
1 1/4 x 36, 42
H 5360
1 5/8 x 36, 42

PRIMED
PR 5060
1 1/4 x 36, 42
PR 5360
1 5/8 x 36, 42

FIR
F 5060
1 1/4 x 36, 42
F 5560
1 1/2 x 36, 42

ALDER
A 5060
1 1/4 x 36, 42

MAPLE
M 5060
1 1/4 x 36, 42

Chamfered Square



OAK
O 5060 CH
1 1/4 x 36, 42

HEMLOCK
H 5060 CH
1 1/4 x 36, 42
H 5360 CH
1 5/8 x 36, 42

Wide



FIR
F 5260
7/8 x 2 x 36, 42



All Iron Balusters in stock are 1/2" x 44"

SQUARE TWIST AND BASKET

Twist
single & double

Basket
single & double

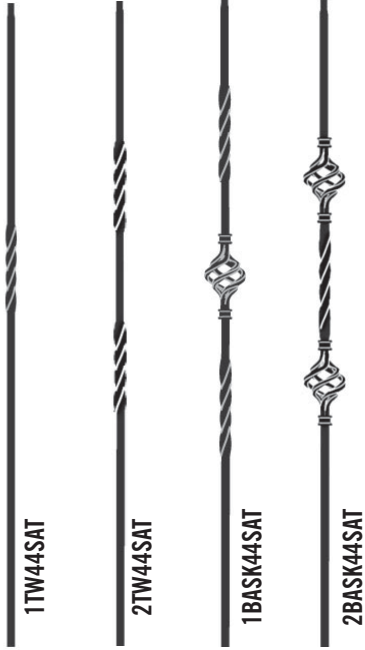

Satin Black In Inventory

SQUARE PLAIN WITH FIXED KNUCKLE

Plain Baluster shown with single and double fixed knuckle.

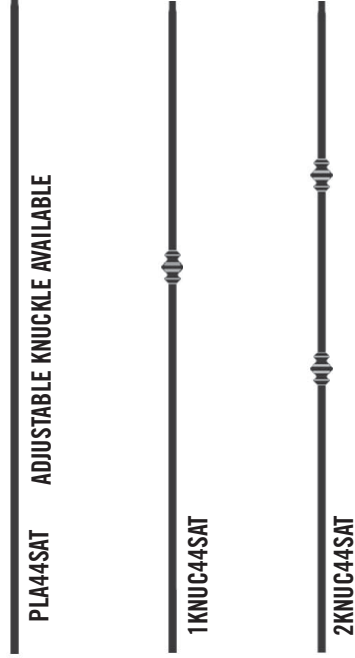

Satin Black In Inventory

ROUND ORB

1/2" Round Balusters

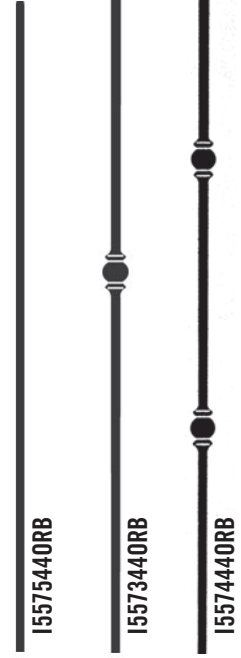

Oil Rubbed Bronze In Inventory



Some examples of the many patterns and finishes available by special order. Typical lead time 3-5 days.

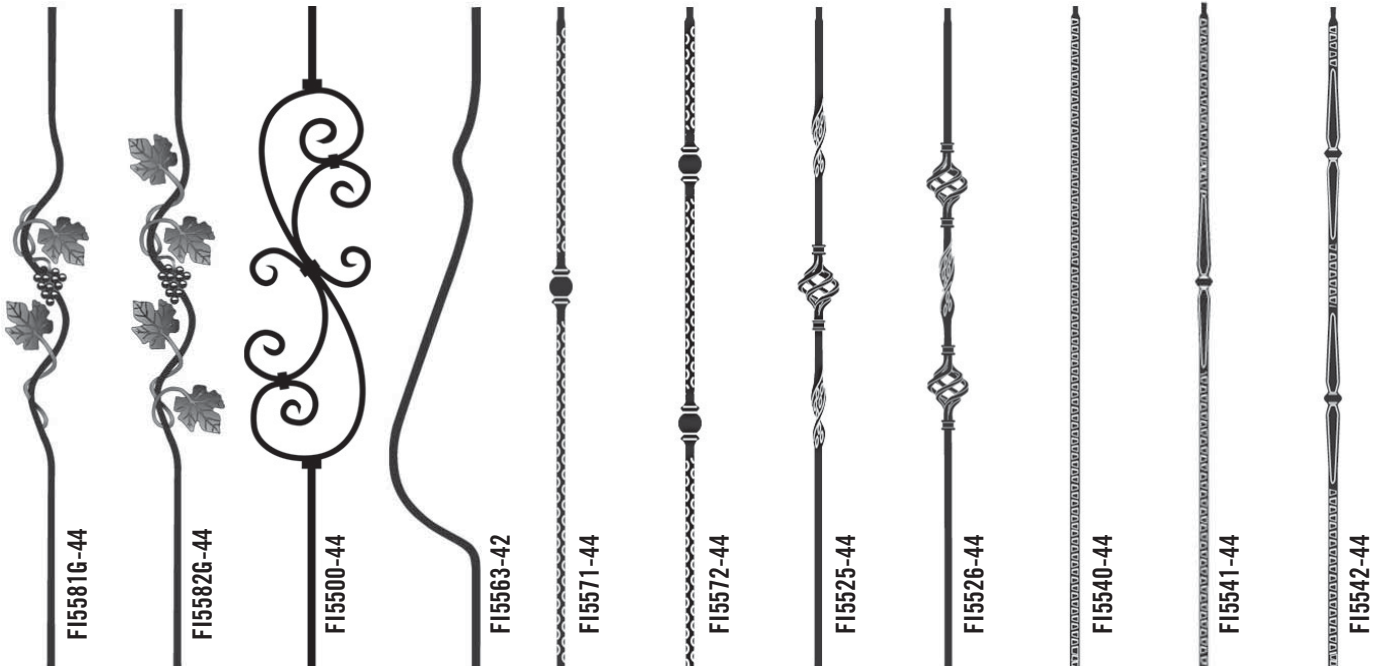

I3101-50RB



Round Shoe
Oil Rubbed Bronze

I3102RB



Round-Pitch Shoe
Oil Rubbed Bronze

AK01SAT



Adjustable Knuckle with
Set Screw
Satin Black

PSH02SAT ALUM



Pitch Shoe with
Set Screw
Satin Black

MO6SAT ALUM



Tall Flat Shoe with
Set Screw
Satin Black

A501K



Epoxy Kit

*Fast drying(5-7 minute work time)

Will install approx. 30-40 balusters
(anchoring both ends)

*Kit included 5 oz. A-7 epoxy, A-24 nozzle
& piston for use with standard caulking gun

STAIR ACCESSORIES

WALL ROSETTES

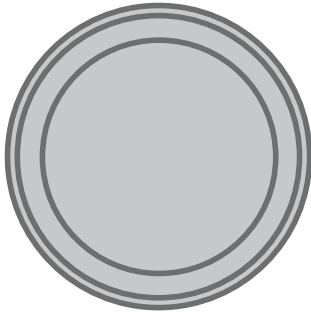

Round
4 1/2" x 3/4"
O 7017 OAK
H 7017 HEMLOCK

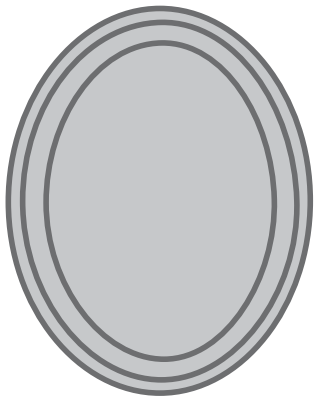

Oval Wide
4 1/2" x 5 3/4" x 3/4"
O 7037 OAK
M 7037 MAPLE
C 7037 CHERRY
H 7037 HEMLOCK

Oval Narrow
3 9/16" x 5" x 3/4"
O 7027 OAK
M 7027 MAPLE
A 7027 ALDER

FLUTED DOWEL PINS



MG6200
3/8" x 2"

FACE GRAIN PLUGS BUTTONS

	3/8"	1/2"	3/4"	1"	1 1/2"	3/8"	1/2"	1"
Birch	X	X				X	X	X
Oak	X	X	X	X	X	X	X	X
Maple				X	X			
Cherry		X		X	X			
Alder				X	X			
Hemlock				X				
Fir				X	X			

PYRAMID CAPS

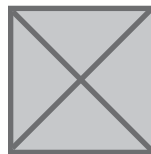

5 x 5 x 1 1/2"

Add a pyramid cap and panel
mould to a plain shaft to
create a simple box newel.

Alder 5"	PC 55A
OAK 5"	PC 550
MAPLE 5"	PC 55M
CHERRY 5"	PC 55C
HEMLOCK 5"	PC 55H
FIR 5"	PC 55F
FIR 7 1/4"	PC 725F

• Ask about our stair accessory kit for the professional installer •



TREADS

1 ¹ / ₁₆ x 11 ¹ / ₂	36"	42"	48"	60"
Oak	X	X	X*	X
Maple			X	
Alder			X	
Hemlock			X	
Particle Board			X	
CVG Fir (1 x 11 ¹ / ₄)	Random Lengths			

Many other tread species available.

***48" Oak treads in inventory with left or right mitered return on nosing for open ended stairs. Mitered returns for all treads available by special order.**

RISERS

Our Risers are made of solid wood – no veneer or plywood.

OAK– O 980, 3/4 x 7 1/2 x 36,42, 48

Hardwood or paint-grade risers may be cut from plywood or 1x8 lumber.

BENDING BLANK



OAK	16'
MAPLE	16'
CHERRY	12'



Landing Tread	OAK O 988	MAPLE M 988
5 1/2 x 3/4 x 1 1/16	CHERRY C 988	HEM H 988 (not rabbeted)



Landing Tread	OAK O 987	
3 1/2 x 3/4 x 1 1/16	FIR F 987	HEM H 987 (not rabbeted)

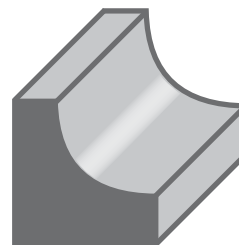

Tread Mouldings
3/4 x 3/4

OAK	O 601
MAPLE	M 601
CHERRY	C 601
HEM	H 301 (1 1/16 x 1 1/16) 8', 10', 12'
FIR	F 301
ALDER	A 601

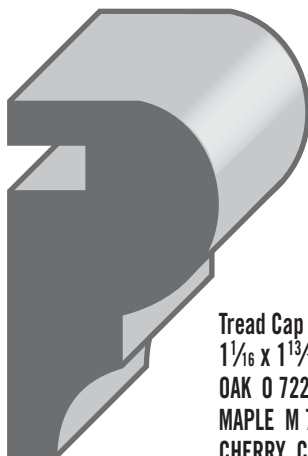

Tread Cap Mould
1 1/16 x 1 13/16

OAK	O 722
MAPLE	M 722
CHERRY	C 722

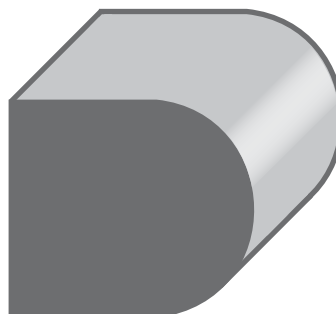

Nosing
1 1/4 x 1 1/16

OAK	O 986
MAPLE	M 986
CHERRY	C 986
HEM	H 986
FIR	F 986 (1 x 1 1/16)
ALDER	A 986
POPLAR	P 986 (1 1/8 x 2)



Single-Ended Starting Step
(Shoe and cove moulding included)*

OAK O 8010 48"

Other wood species and sizes available by special order.

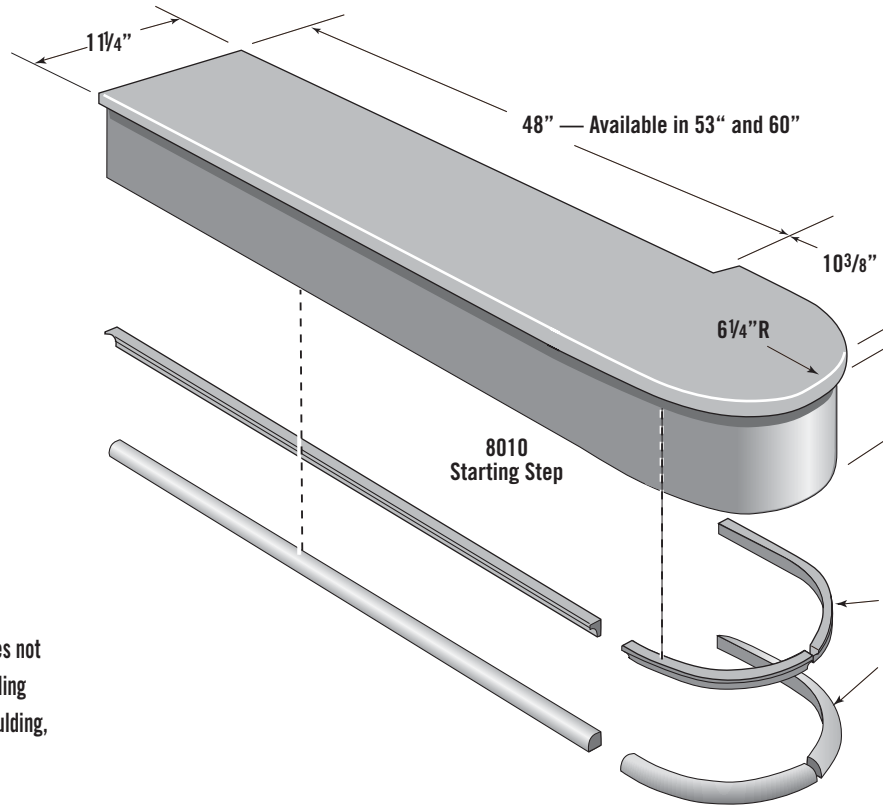

*Curved moulding included with starting steps does not match stock shoe and cove profiles. Curved moulding kits, as well as 5' straight lengths of matching moulding, may be purchased separately.



TREAD CAP SYSTEM

